

**Pour l'horloger...
Für den Uhrmacher...
For the watchmaker...
Para el relojero...**

No. 200 avec 400 compartiments pour pochettes standardisées RONDA.

mit 400 Einteilungen für RONDA-Tüten einheitlicher Größe.

with 400 divisions for standardized RONDA envelopes.

con 400 compartimentos para sobrecitos RONDA tamaño uniforme.

No. 205 pour 420 balanciers réglés für 420 reglierte Unruhen for 420 complete balances para 420 volantes completos

A l'aide de ciseaux, les plateaux UNIVERSAL peuvent être sectionnés à toute largeur désirée de vos tiroirs. Stockage propre et clair sur une place restreinte. Demandes et offres par votre grossiste habituel.

UNIVERSAL-Einsätze können mit der Schere für Ihre eigenen Schubladen zugeschnitten werden. Saubere und übersichtliche Lagerhaltung auf kleinstem Raum. Anfragen und Offerten durch Ihren Grossisten.

With a pair of scissors, the UNIVERSAL tray can be cut up to any width of your drawers. Clear and space-saving stockage. Inquiries and offers through your material dealer.

Los estantes UNIVERSAL se pueden cortar con las tijeras a la anchura deseada de sus propios cajones. Almacenaje racional y claro en poco espacio. Información y ofertas a través de su mayorista.

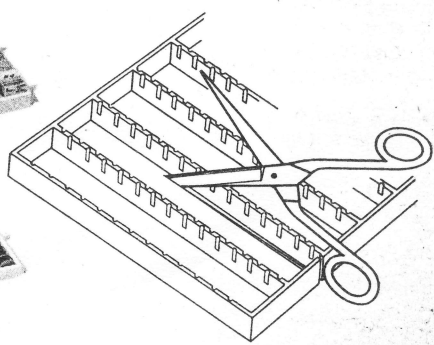
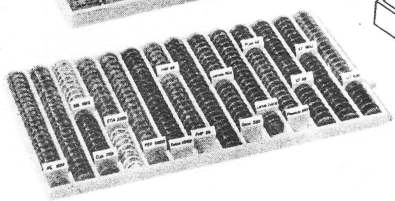
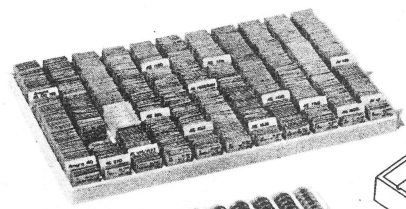
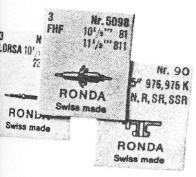

6x8-5001
5152
FLEX

**Coffret d'assortiment
TIGES DE REMONTOIR No. 700**

en bakélite à 9 tiroirs,
640 calibres à 2 tiges,
80 tubes vides numérotés
en rouge dans le 9e tiroir.

**AUFZUGWELLEN-Sortiment-
kasten Nr. 700**

aus Bakelit mit 9 Schubladen,
640 Kaliber zu 2 Wellen,
80 rot nummerierte Tuben
in der 9. Schublade.

**WINDING STEM
assortment case No. 700**

of bakelite with 9 drawers,
640 calibres at 2 stems each,
80 red numbered empty tubes
in the 9th drawer.

**Cassetta di assortimento
ALBERI DI CARICA No. 700**

en bakelita con 9 cassettei,
640 calibri a 2 alberi,
80 tubi vuoti numerati
in rosso nel 9o cassetto.

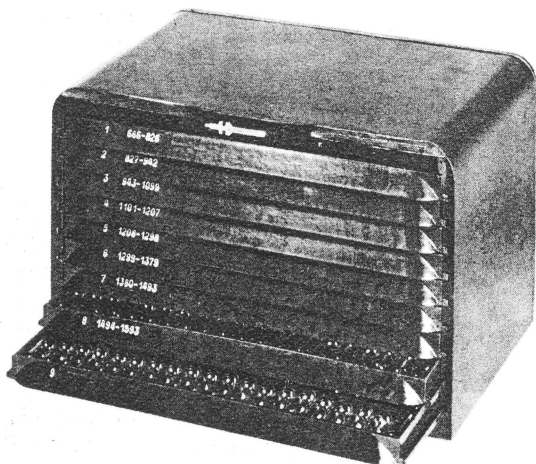

Dimensions extérieures / Aussenabmessungen
Outer dimensions / Dimensioni esterne
20,2x14,2x14,0 cm (8"x5½"x5½" approx.)

Poids net / Nettogewicht
Net weight / Peso netto
kg 1,900 (4 lbs. 3 oz.)

Table des matières / Inhaltsverzeichnis / Index / Indice:

Contenu dans le coffret RONDA I = *
Im Sortimentskasten RONDA I enthalten = *
Contained in RONDA I cabinet = *
Contenuto nella cassetta RONDA I = *
Incluido en el casillero RONDA I = *

RONDA III = ▲
RONDA III = ▲
RONDA III = ▲
RONDA III = ▲
RONDA III = ▲































Le coffret d'assortiment N° 3 contient les calibres les plus récents ainsi que les références courantes des coffrets N° 1 et 2.

Im Sortimentkasten Nr. 3 sind die neuesten Kaliber sowie die kuranten aus den Kasten Nr. 1 und 2 enthalten.

Assortment case No. 3 contains the latest calibres together with the most demanded ones of case No. 1 and 2.

La cassetta die assortimento No. 3 contiene i più recenti calibri e le referenze più conosciute delle cassette No. 1 e 2.

Répertoire des marques - Markenverzeichnis - Index of trademarks
 - Indice delle marche - Índice de marcas - Índice das marcas

		page Seite página			page Seite página
	AHO	1		Béguelin = Damas	9
	AHS = LORD	1		Benrus	4
	Alpina	1		Bentima = Oris	24
	AM	1		Bettlach = EB	9
	Amida	1		BFG	5
	Angélus	2		Bidlingmaier	5
	AR = Enicar	11		Bifora = Bidlingmaier	5
	Arday	2		Brac	5
	Arogno	2		Bulla = Juillard	18
				Bulova	6
	AS	2		Buren	6
	A. Schild = AS	2		Buser	6
	Asco	4		Canava = Durowe	9
	Assa = AS	2		Cattin	7
	Aurore = AV	4		Certina = Kurth	19
	AV	4		Chaika	7
	B = Bidlingmaier	5		Chézard	7
	B = Buser	7		Cimier = Lapanouse	21
	BAA = Buren	6		Citizen	7
	Bauer, Gustav = GUBA	17		Civitas = Moeris	23
	Bauer H.F.	4		Cort = Cortébert	8
	Baumgartner = BFG	5		Cortébert	8
	Becker = HB	18		Court Watch Co. = Essor	11

		page		page	
		Seite		Seite	
		página		página	
	Culmina	8		Eppler	11
	Cupillard	8		ES (Ebauches Sonceboz)	11
	Cyma	8		Essor	11
	Cyrus = Revue	27		Estrella = Venus	31
	Dama	8		ET = Eberle	10
	Damas	9		ETA	11
	Derby	9		Eterna	13
	Desa	9		EUW = Vufe	31
	Diehl	9		Favre-Leuba	13
	Dila = Freco	17		Favre Marc = MF	22
	Doxa	9		FE (France Ebauches)	14
	Duke	9		FEF	14
	Duro = Durowe	9		Felsa	14
	Durowe	9		Femga = Dama	8
	EB	9		FG (Girardet)	15
	Eberle	10		FHF	15
	Ebosa	10		Fiomi	16
	EJ = Juillard	18		Fleurier = FEF	14
	Election	10		Font = FHF	15
	Elgin	11		Förster	16
	Emes = Müller-Schlenker	24		Freco	17
	Enicar	11		Frenca = Buser	6
	Epora = Epplé	25		Frey = Freco	17
	O. Epplé = Otero	25		Gala = Liengme	21

CV R PARRENIN